



TS 73 V

Door Closer

Easy to fit, economical and with adjustable closing force

Simple, easy installation, and guaranteed quality.

Tested to EN 1154

Specially designed for internal doors, including fire doors, the DORMA TS 73 V is a universal solution for doors of differing designs and styles.

The flat and compact format of the TS 73 V means that there are practically no problems with installation; and tried and trusted quality is your assurance of reliability. Certified to ISO 9001

Why everyone gains – point by point

For the trade

- One model for all applications.
- Really practical solutions for special installation situations, thanks to the wide range of accessories.

For the installer

- Quick and simple to fit. Closing force, closing speed, and latching action all set with just a few manual adjustments.
- Only one design for DIN-L and DIN-R doors, and for standard and framefixing.

For the designers

- Compact format in time-less design.
- Attractively-priced solution with optimum reliability.
- Wide range of applications.
- Anti-corrosive design for moist and damp areas.

For the user

- Optimum wall and door protection thanks to "thinking" backcheck.
- Constant closing speed virtually unaffected by temperature fluctuations, with adjustable latch action.
- Smooth door action thanks to high mechanical efficiency.



The TS 73 V complies with the requirements and/or recommendations of the following: CERTIFIRE approved for fire doors ITT 120; MM/IMM 240; Ref. CF 117

Data and features

TS 73 V

Closing force adjustable	Size	EN 2-4
Standard doors ¹⁾	≤ 1100 mm	●
External doors, opening outwards ¹⁾		–
Fire and smoke control doors ¹⁾	≤ 1100 mm	●
Non-handed		●
Arm	Standard	●
	Flat form	●
	Slide channel	–
Closing force adjustable by means of setting screw		●
Closing speed adjustable at 2 separate valves	180° - 15°	●
	15° - 0°	●
Backcheck	self-regulating	●
	adjustable at valve	●
Adjustable latching action	by arm	●
Delayed action		–
Hold-open		○
Weight in kg		1.3
Dimensions in mm	Length	225
	Depth	40
	Height	60
Door closer tested to EN 1154		●
CE mark for construction products		●

● Yes – No ○ Option

¹⁾ For high and heavy doors, external doors, and for doors required to close against high wind pressure, we recommend DORMA TS 83.

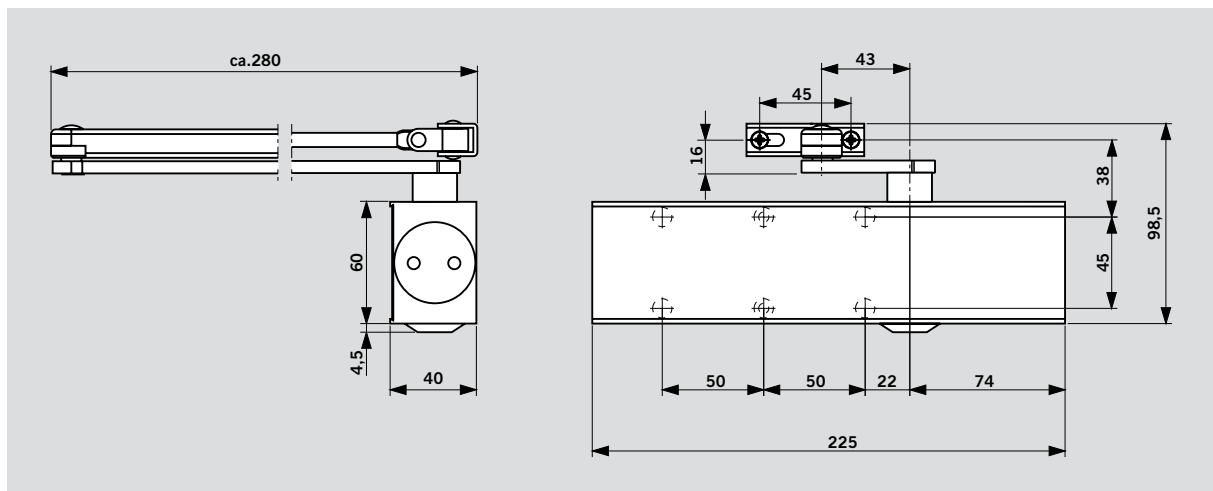

Features and optional functions

With “thinking” backcheck (BC/ÖD)

Thanks to an innovative design concept, the resistance developed by this backcheck system as the door is opened beyond approx. 70° is directly proportional to door acceleration.

It is almost imperceptible when the door is opened slowly. However, if the door is opened hastily, the backcheck responds in equal measure.

And if the door should be flung open at speed – whether deliberately, thoughtlessly, accidentally or as a result of a gust of wind – the backcheck reacts at full strength, protecting the wall and door from damage.

If no backcheck function is required, the system can simply be switched off.

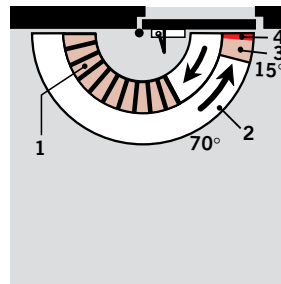

- 1 Self-regulating backcheck
- 2 Infinitely variable closing speed in the range 180° – 15°
- 3 Infinitely variable closing speed in the range 15° – 0°
- 4 Adjustable latch range (by arm)

With hold-open arm

Combining the TS 73 V with a hold-open arm enables the door to be held open at an appropriate angle (up to approx. 150°).

Hold-open arm with switch: The hold-open function can be switched on and off by the user by simply pressing a switch.

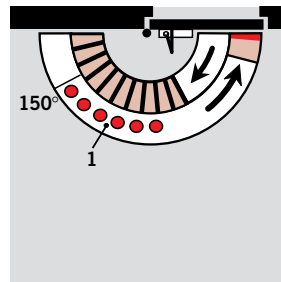

- 1 Hold-open range

Hold-open arms are not permitted on fire doors

Door leaf fixing, pull side (example shows LH (ISO 6) door; RH (ISO 5) doors mirrored arrangement)

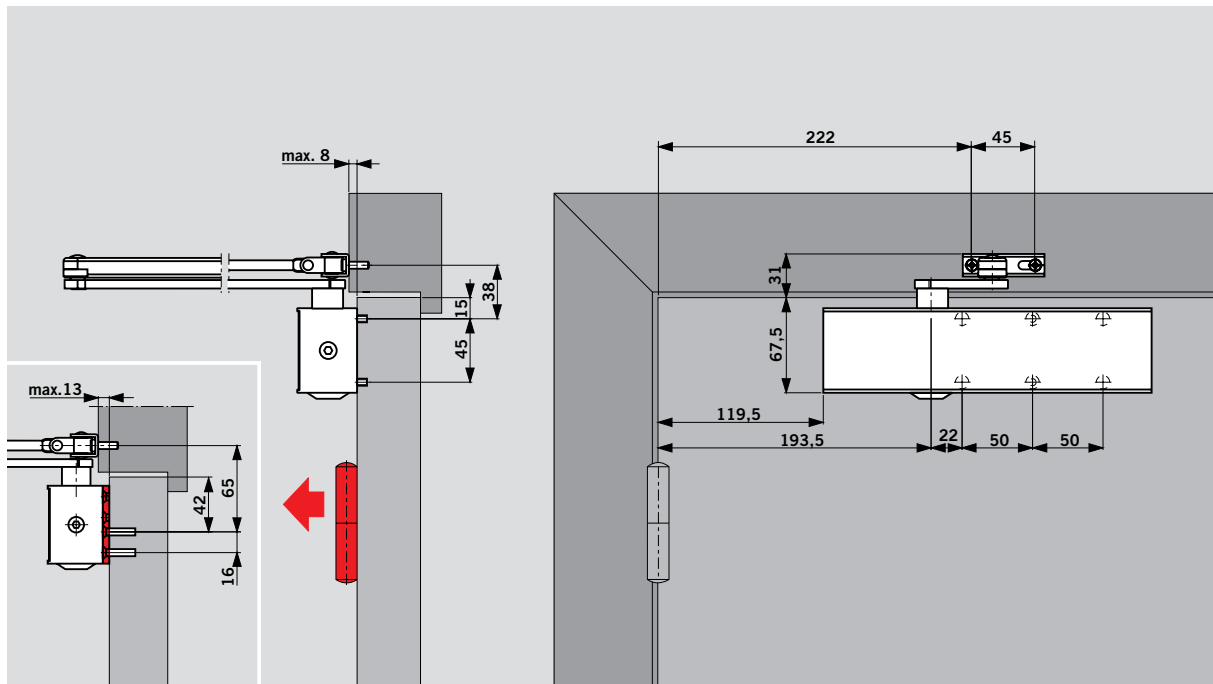

Door leaf fixing with hold-open arm (example shows LH (ISO 6) door; RH (ISO 5) doors mirrored arrangement)

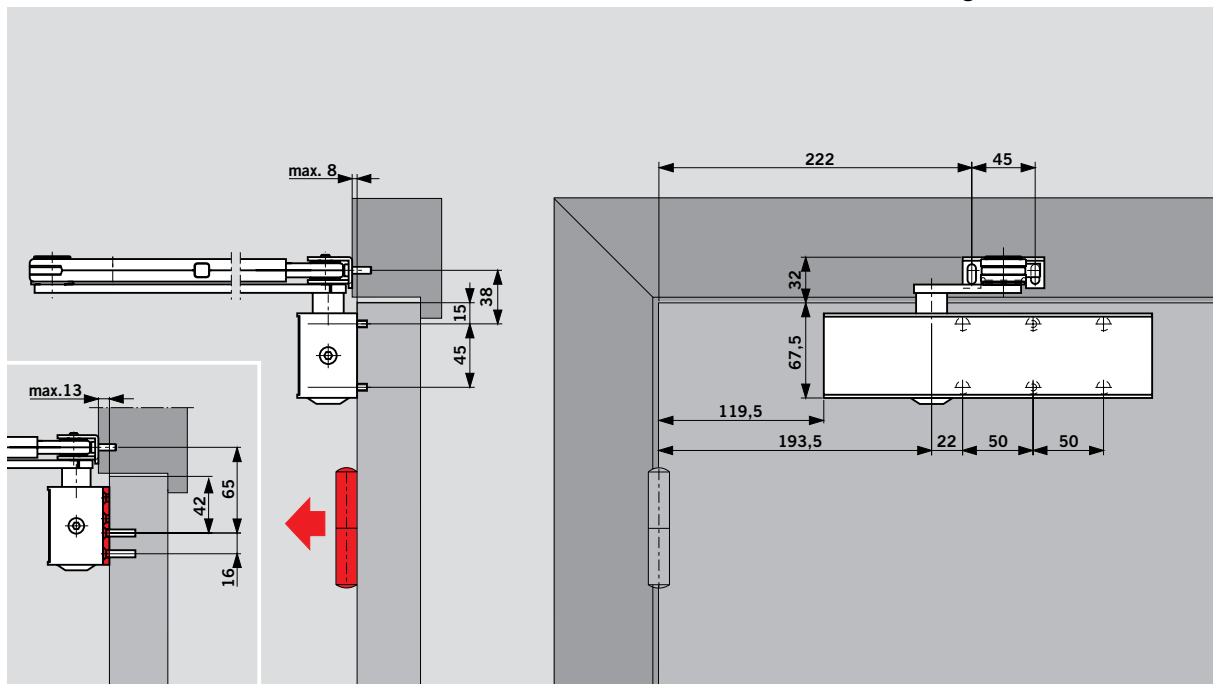

Transom fixing, push side (example shows LH (ISO 6) door; RH (ISO 5) doors mirrored arrangement)

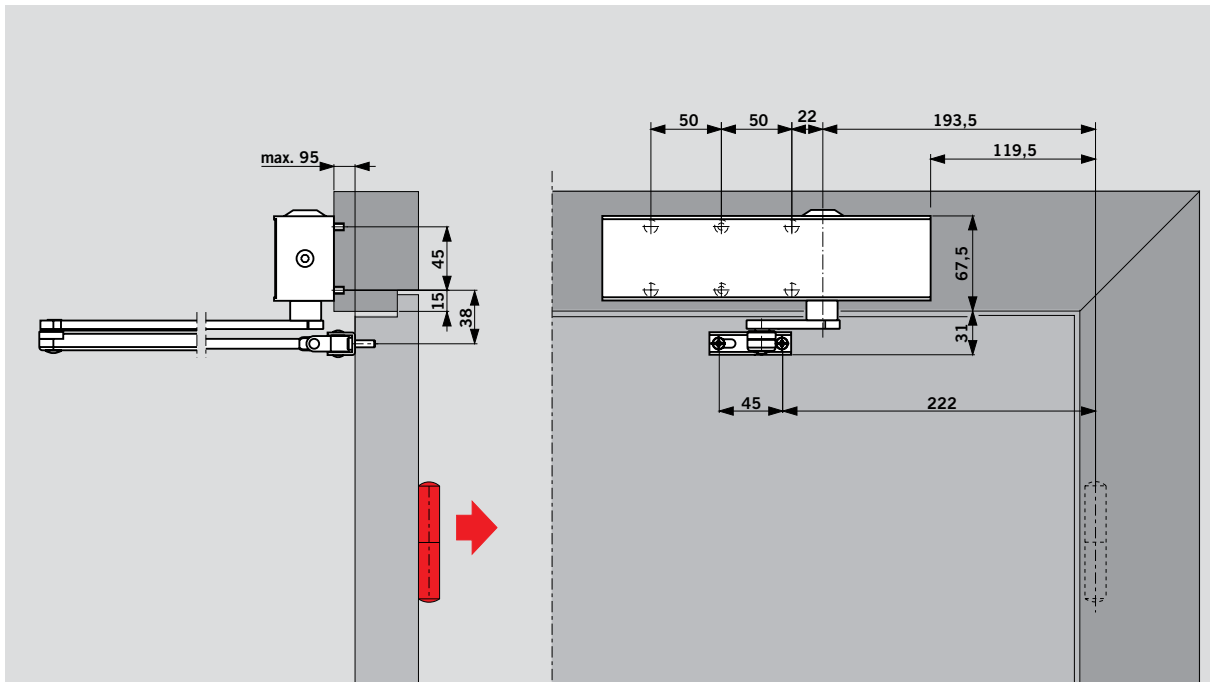

Door closers may only be fitted on the frame of fire doors if proved suitable for the individual door by the issue of an approval certificate from a recognised testing institution.

Mounting plate TS 73 V

For fitting the door closer to fire doors and to doors where direct fitting is not possible. Hole group according to EN 1154, supplement 1.

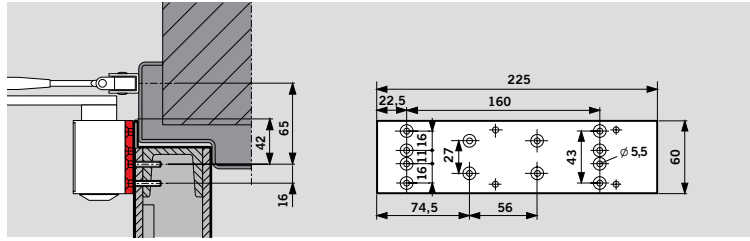

Hinge plate TS 73 V/TS 83

For securing the arm to particularly narrow door frames.

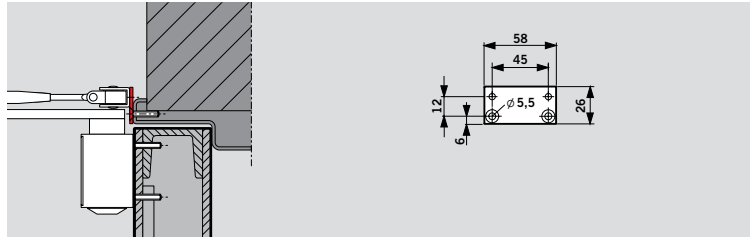

Angle bracket TS 73 V

For overhead fitting on the push side, for deep-set door lintels. **On fire doors, proof of suitability required in relation to the individual door concerned.**

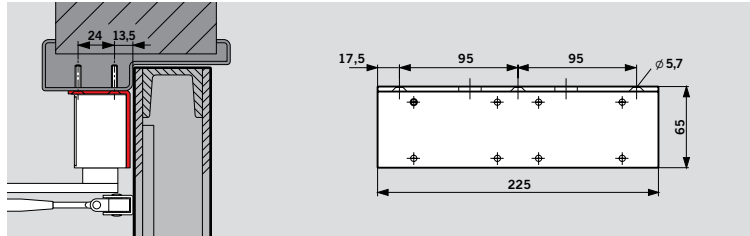

Drop plate TS 73 V/TS 83

For use where the closer cannot be fitted directly to the door. **On fire doors, proof of suitability required in relation to the individual door concerned.**

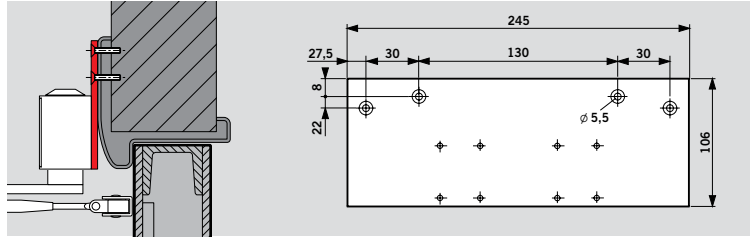

Parallel arm bracket TS 73 V/TS 83



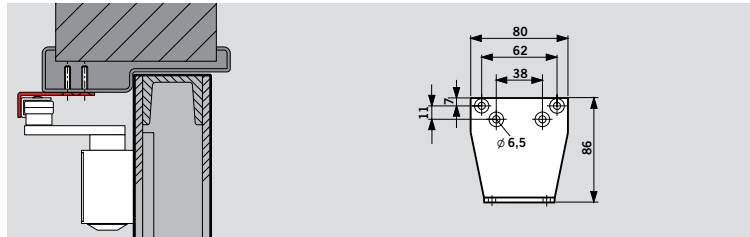



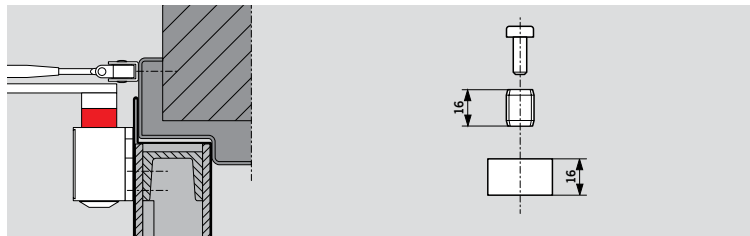

For parallel arm installation (see installation instructions for fitting dimensions). **On fire doors, proof of suitability required in relation to the individual door concerned.**

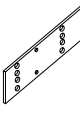

Spindle extension TS 73 V/TS 83

For increasing the distance between the closer and the arm assembly in the case of doors with a high overlap; 16 mm high.

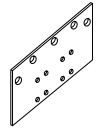
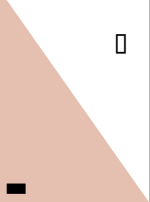
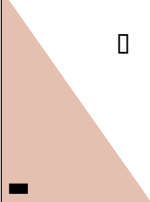
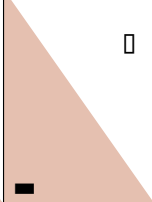

Range of equipment				Accessories			
Closer body TS 73 V 	Standard arm  □ 220023xx	Flatform arm  □ 830001xx	Hold-open arm with on/off switch  □ 220030xx	Mounting plate  370001xx	Hinge plate  830014xx	Angle bracket  370003xx	Drop plate  380002xx
Size EN 2-4 ■ 370101xx	 □	 □	 □	Parallel arm bracket  280066xx	Spindle extension 16 mm  83003705		

Order number:

■ = Body only

□ = Arm only

Colour	xx
silver	01
white (RAL 9016)	11
special	09

Specification text

DORMA TS 73 V rack and pinion door closer; with adjustable power size EN 2 – 4, according to EN 1154, carries the CE mark, integral self-regulating backcheck; closing speed adjustable in two independent ranges and adjustable latch action. Non-handed.

Model

- with standard arm
- with flatform arm
- with hold-open arm with on/off switch

Accessories _____

Colour

- Silver
- White (sim. RAL 9016)
- Special _____ (sim. RAL _____)

Make: DORMA TS 73 V
 TS73V



www.dorma.com

WN 053 211 51532, 11/11, TS 73 V, GB, x. xx. xx/11 . Subject to change without notice



DORMA GmbH + Co. KG
DORMA Platz 1
D-58256 Ennepetal
Phone +49 2333 793-0
Fax +49 2333 793-4950