

referência / reference

peso embalagem / weight pack

embalagem / pack

800

2,20 kg

5

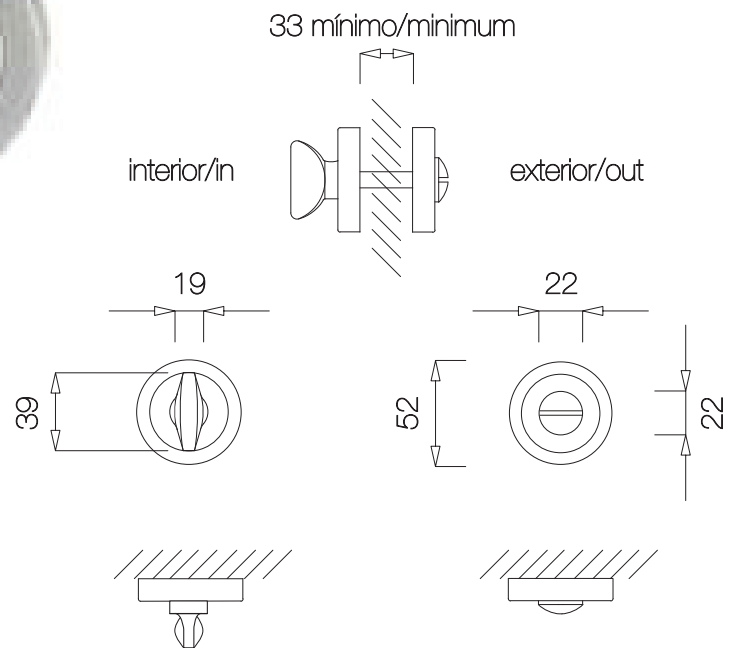

cromado brilhante/aço inox satinado  
bright chrome/satin stainless steel  
(67)



cromado veludo mate/aço inox satinado  
mate chrome velvet/satin stainless steel  
(81)