

referência / reference

peso embalagem / weight pack

embalagem / pack

793

7,40 kg

8

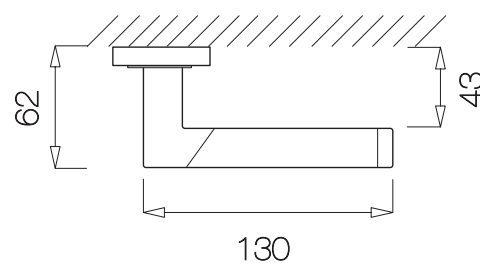
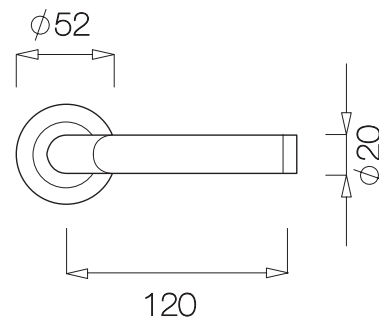
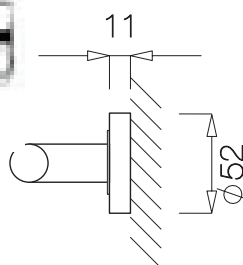
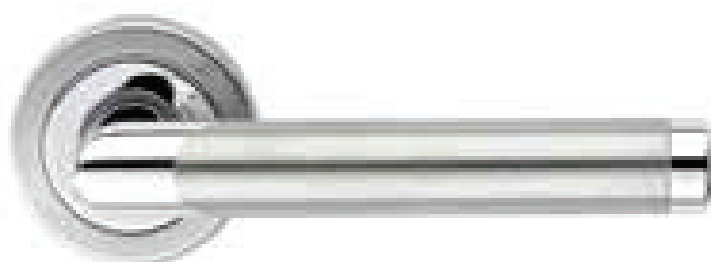

cromado brilhante/aço inox satinado
bright chrome/satin stainless steel
(67)

cromado veludo mate/aço inox satinado
mate chrome velvet/satin stainless steel
(81)