



**SISTEMAS MODULARES
PARA CABINES
SANITÁRIAS /
SANITARY BOOTH
HARDWARE/
HERRAJES PARA
CABINAS SANITÁRIAS.**

SISTEMAS MODULARES PARA CABINES SANITÁRIAS / SANITARY BOOTH HARDWARE / HERRAJES PARA CABINAS SANITÁRIAS.

A JNF tem uma gama completa de ferragens em Aço Inox para construção de módulos sanitários ou gabinetes em painéis fenólicos. As ferragens são fabricadas em Aço Inox EN 1.4301 e EN 1.4401, no acabamento escovado e em alguns casos mais específicos têm um revestimento superficial de titânio.

Toda a ferragem é aplicável a painéis com 13 ou 10 mm de espessura. Os tubos estruturais são de diâmetro 19 e 25 mm.

JNF have a full range of fittings in stainless steel for construction of sanitary modules in phenolic panels. The fittings are made in stainless steel EN 1.4301 and EN 1.4401, satin finish and in some specific cases have a titanium coating.

All hardware is applicable to panels with 13 or 10 mm thick. Structural tubes are 19 and 25 mm diameter.

JNF tiene una gama completa de accesorios en acero inoxidable para la construcción de módulos sanitarios en paneles fenólicos. Los accesorios son hechos en acero inoxidable EN 1.4301 y EN 1.4401, acabado satin y, en algunos casos específicos tienen un recubrimiento de titanio.

Todas las herrajes son aplicables a los paneles con 13 o 10 mm de espesor. Tubos estructurales son de 19 y 25 mm de diámetro.

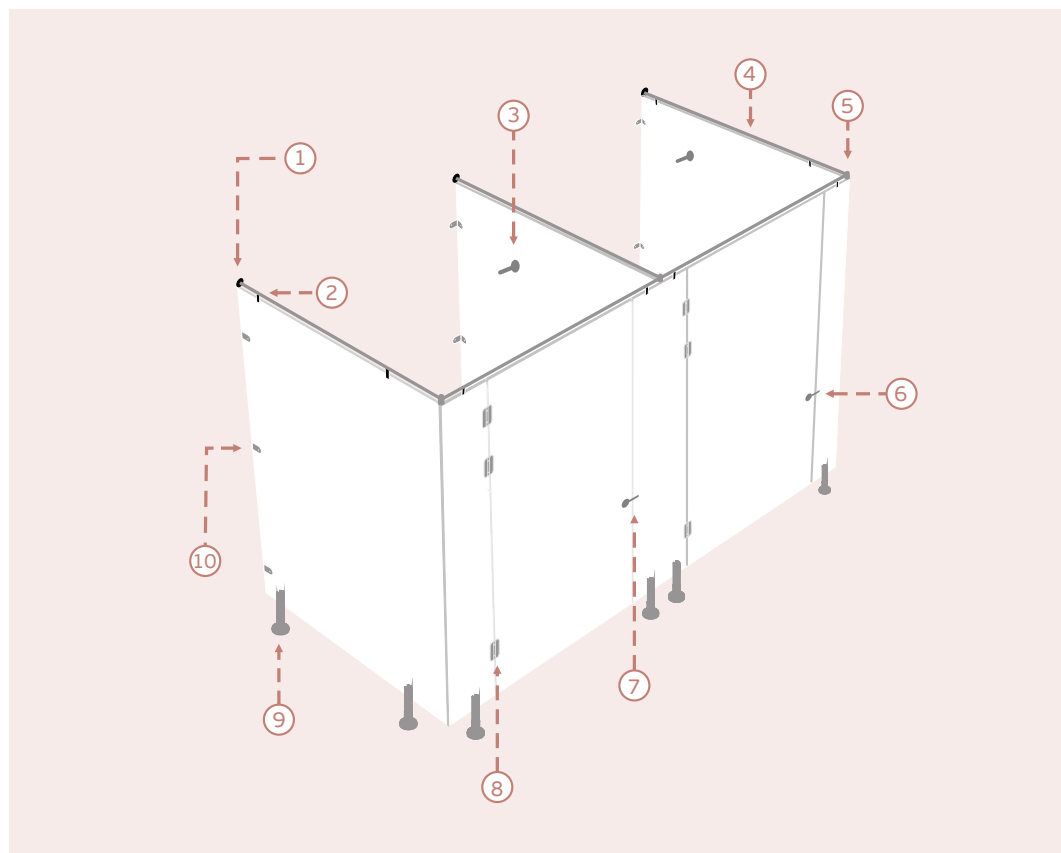

EXEMPLO DE UTILIZAÇÃO DAS FERRAGENS PARA MÓDULOS SANITÁRIOS /

APPLICATION EXAMPLE OF THE SANITARY HARDWARE /

EJEMPLO DE APLICACIÓN DE LAS HERRAJES PARA CABINAS SANITÁRIAS.

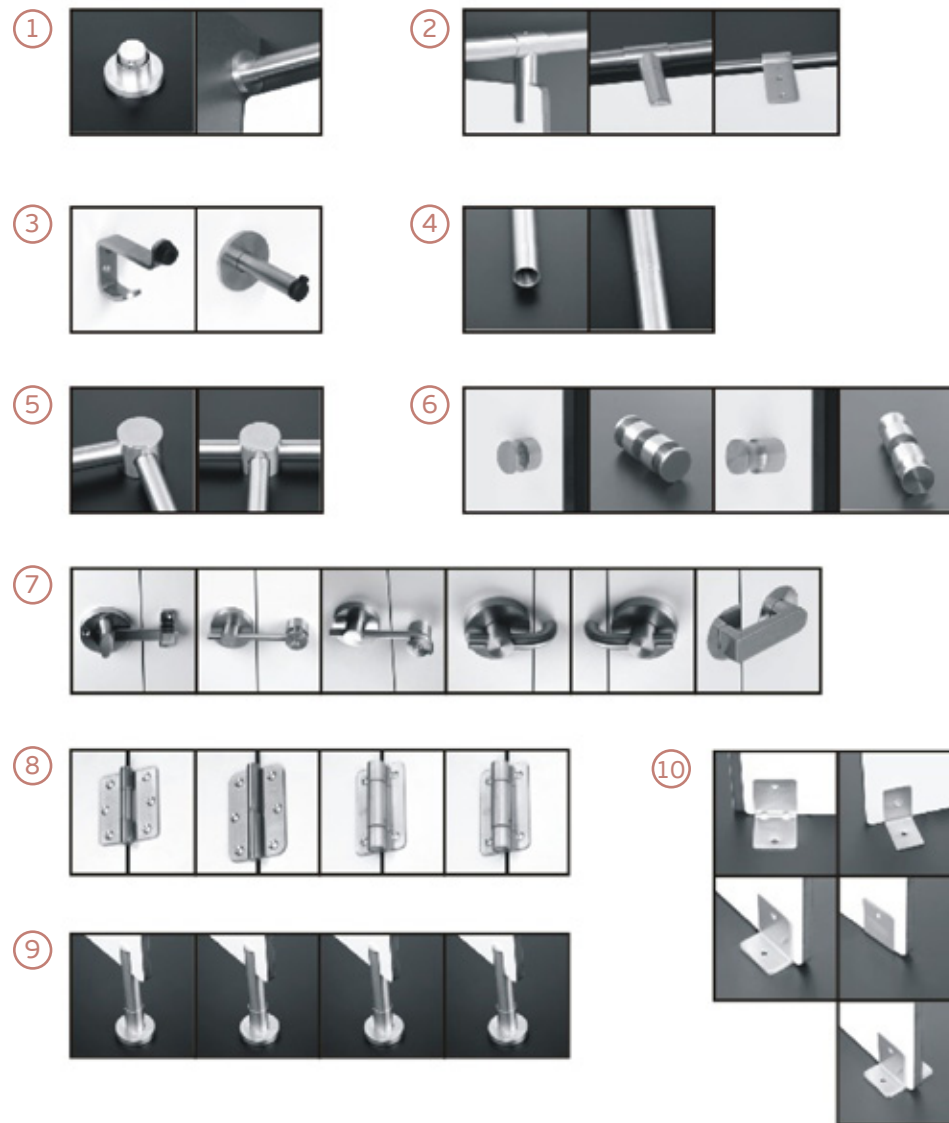

SISTEMAS MODULARES PARA CABINES SANITÁRIAS / SANITARY BOOTH HARDWARE / HERRAJES PARA CABINAS SANITÁRIAS.



Também disponível na versão: /
Also available in version: /
Tambien disponible en la versión:
EN 1.4372

ECO series

SM.005.A
Dobradiça. Direita ou esquerda /
Lift off hinge. Right or left hand /
Bisagra. Derecha o izquierda.
EN 1.4301 Satinado / Satin / Satin

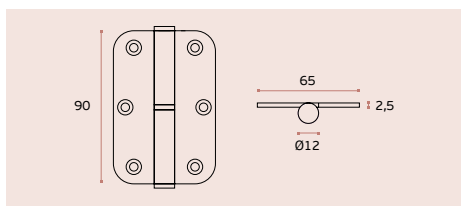

SM.005.B
Dobradiça /
Hinge /
Bisagra.
EN 1.4301 Satinado / Satin / Satin

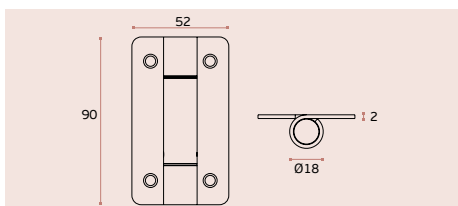

SM.005.C
Dobradiça com mola /
Hinge with spring /
Bisagra con muelle.
EN 1.4301 Satinado / Satin / Satin

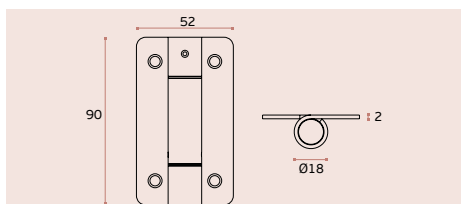

SM.005.D
Dobradiça /
Hinge /
Bisagra.
EN 1.4301 Satinado / Satin / Satin

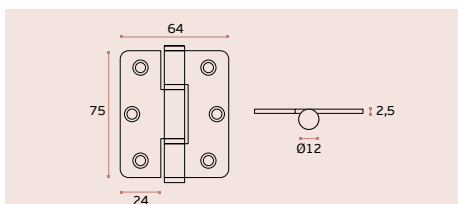

Também disponível na versão: /
Also available in version: /
Tambien disponible en la versión:
EN 1.4372

ECO series



Base para painel fabricada em Aço Inox EN 1.4401 e EN 1.4301.
Fixação ao solo através duma sólida base metálica. O ajuste do suporte em altura é possível mesmo com a base já fixa ao solo e o painel já instalado.

Adjustable foot made in Stainless Steel EN 1.4401 and EN 1.4301.
Fixing on the floor trough a strong metallic base. The height it's adjustable even with the base already fixed on the floor and the panel on the support.

Pie regulable fabricado en Acero Inox EN 1.4401 y EN 1.4301.
Sujecion al suelo atraves de solida base metalica. El ajuste es posible mesmo despues de la sujecion de la base al suelo y del panel en al soporte.

SM.017
Base regulável para painel /
Adjustable foot /
Pie regulable.

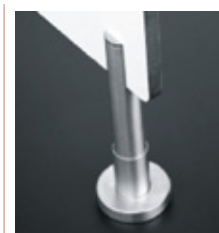
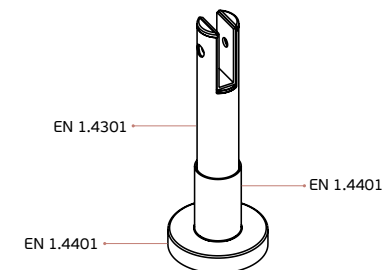
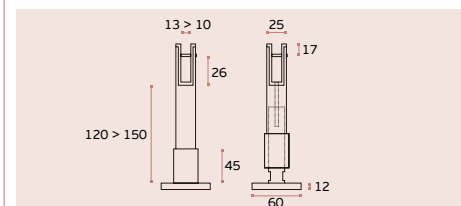

Base para painel fabricada em Aço Inox EN 1.4401 e EN 1.4301.
Fixação ao solo através duma sólida base metálica. O ajuste do suporte em altura é possível mesmo com a base já fixa ao solo e o painel já instalado.

Adjustable foot made in Stainless Steel EN 1.4401 and EN 1.4301.
Fixing on the floor trough a strong metallic base. The height it's adjustable even with the base already fixed on the floor and the panel on the support.

Pie regulable fabricado en Acero Inox EN 1.4401 y EN 1.4301.
Sujecion al suelo atraves de solida base metalica. El ajuste es posible mesmo despues de la sujecion de la base al suelo y del panel en al soporte.

SM.017.XL
Base regulável para painel /
Adjustable foot /
Pie regulable.

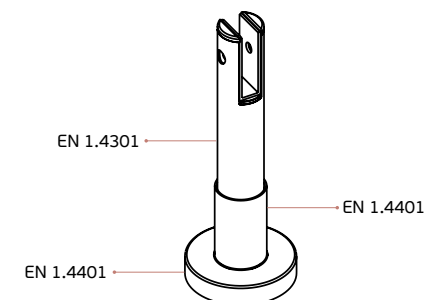
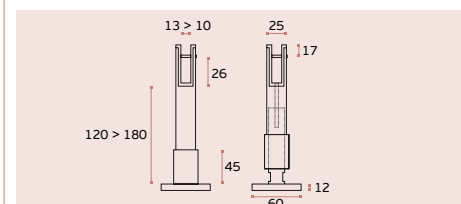

SISTEMAS MODULARES PARA CABINES SANITÁRIAS / SANITARY BOOTH HARDWARE / HERRAJES PARA CABINAS SANITÁRIAS.

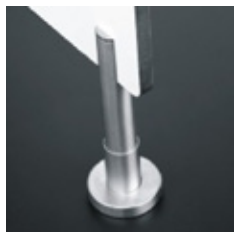

Base para painel fabricada em Aço Inox EN 1.4301 revestido a Titânio, elevadíssima resistência à abrasão e corrosão. Fixação ao solo através duma sólida base metálica. O ajuste do suporte em altura é possível mesmo com a base já fixa ao solo e o painel já instalado.

Adjustable foot made in Stainless Steel EN 1.4301 Titanium coating, very high resistance to the abrasion and corrosion. Fixing on the floor trough a strong metallic base. The height It's adjustable even with the base already fixed on the floor and the panel on the support.

Pie regulable fabricado en Acero Inox EN 1.4301 revestido a Titanio, altissima resistencia a la abrasion y corrosion. Sujecion al suelo atraves de solida base metalica. El ajuste es posible mismo despues de la sujecion de la base al suelo y del panel en al soporte.

SM.017.T
Base regulável para painel /
Adjustable foot /
Pie regulable.

TITANIUM

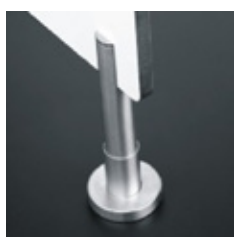
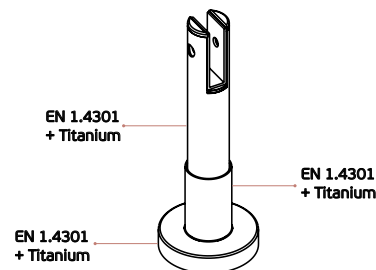
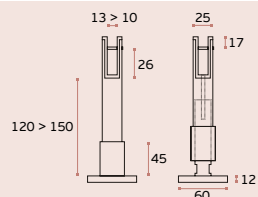

Base para painel fabricada em Aço Inox EN 1.4162. Fixação ao solo através duma sólida base metálica. O ajuste do suporte em altura é possível mesmo com a base já fixa ao solo e o painel já instalado.

Adjustable foot made in Stainless Steel EN 1.4162. Fixing on the floor trough a strong metallic base. The height It's adjustable even with the base already fixed on the floor and the panel on the support.

Pie regulable fabricado en Acero Inox EN 1.4162. Sujecion al suelo atraves de solida base metalica. El ajuste es posible mismo despues de la sujecion de la base al suelo y del panel en al soporte.

SM.025
Base regulável para painel /
Adjustable foot /
Pie regulable.

ECO series

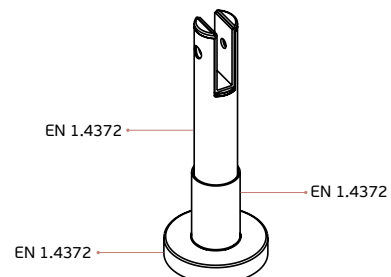
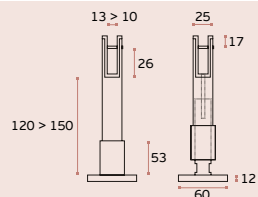

SISTEMAS MODULARES PARA CABINES SANITÁRIAS / SANITARY BOOTH HARDWARE / HERRAJES PARA CABINAS SANITÁRIAS.



SM.002
Suporte superior para painel /
Upper panel holder /
Soporte superior para panel.
EN 1.4301 Satinado / Satin / Satin



SM.002.ECO
Suporte superior para painel /
Upper panel holder /
Soporte superior para panel.
EN 1.4372 Satinado / Satin / Satin

ECO
series

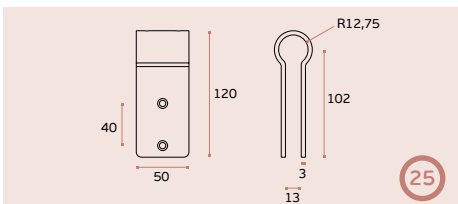
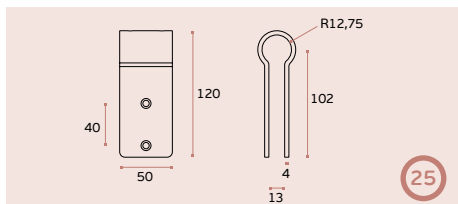

SM.002.19
Suporte superior para painel /
Upper panel holder /
Soporte superior para panel.
EN 1.4301 Satinado / Satin / Satin

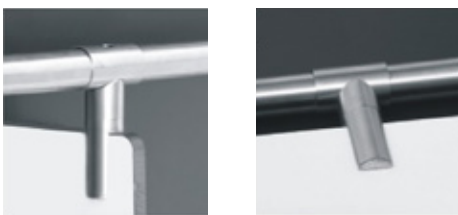

SM.012.90 **SM.012.180**
Suporte superior para painel /
Upper panel holder /
Soporte superior para panel.
EN 1.4301 Satinado / Satin / Satin

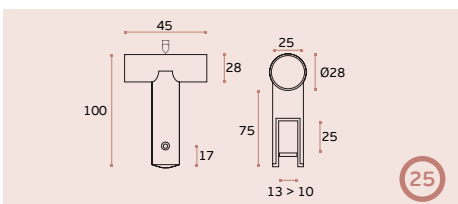
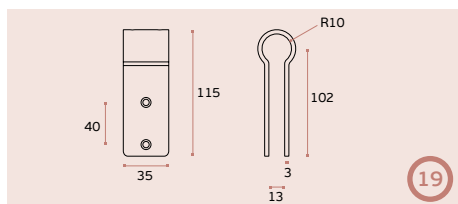

SM.022
Suporte superior para painel /
Upper panel holder /
Soporte superior para panel.
EN 1.4301 Satinado / Satin / Satin

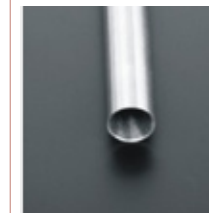

SM.010.A-Ø19 **SM.010.B-Ø19**
SM.010.A-Ø25 **SM.010.B-Ø25**
Tubo / Tube / Tubo.
EN 1.4301 - Satinado / Satin / Satin.

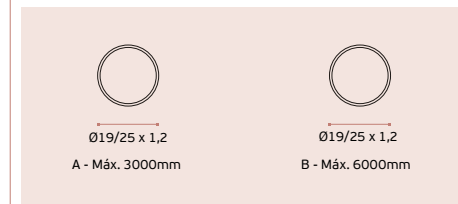
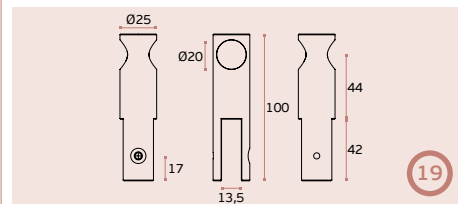

SM.010C - Ø19
SM.010C - Ø25
Conector para tubo /
Tube conector /
Conector de tubo.



SM.011.25
SM.011.19
Suporte de tubo com fixação à parede /
Wall mounting tube support /
Soporte de tubo con sujeción a pared.
EN 1.4301 Satinado / Satin / Satin

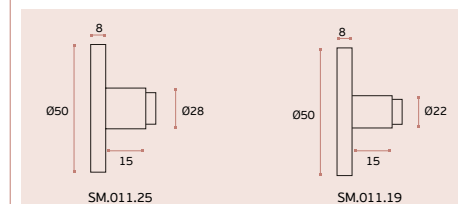
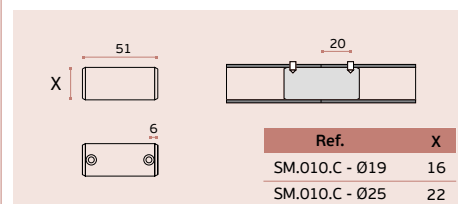

SISTEMAS MODULARES PARA CABINES SANITÁRIAS / SANITARY BOOTH HARDWARE / HERRAJES PARA CABINAS SANITÁRIAS.



SM.032

União de tubo a 90° - para tubo Ø25mm/
Tube connector at 90° - for Ø25mm tube /
Union de tubo a 90° - para tubo Ø25mm.

EN 1.4301 Satinado / Satin / Satin



SM.032.19

União de tubo a 90° - para tubo Ø19mm/
Tube connector at 90° - for Ø19mm tube /
Union de tubo a 90° - para tubo Ø19mm.

EN 1.4301 Satinado / Satin / Satin

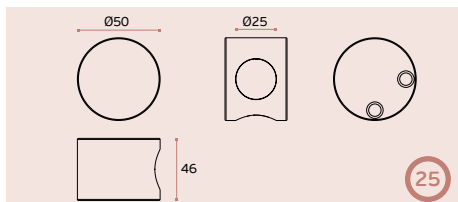

25

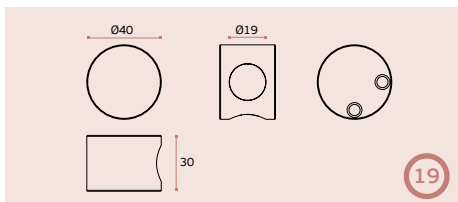

19



SM.033

União de tubo a 90° e 180° - para tubo Ø25mm/
Tube connector at 90° and 180° - for Ø25mm tube /
Union de tubo a 90° y 180° - para tubo Ø25mm.

EN 1.4301 Satinado / Satin / Satin

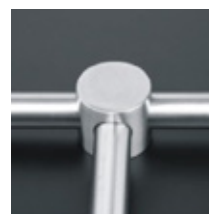

SM.033.19

União de tubo a 90° e 180° - para tubo Ø19mm/
Tube connector at 90° and 180° - for Ø19mm tube /
Union de tubo a 90° y 180° - para tubo Ø19mm.

EN 1.4301 Satinado / Satin / Satin

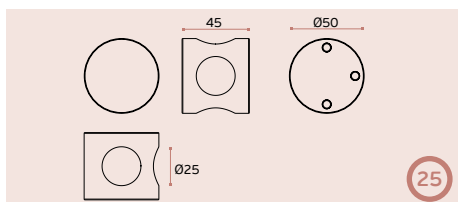

25

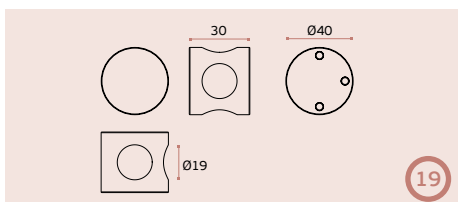

19

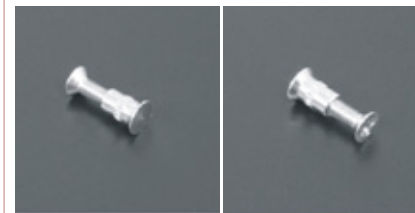

SM.040

Parafuso de ligação para acessórios de fenólico /
Screw connection for phenolic accessories /
Tornillo pasante de conexión para accesorios de fenolico.

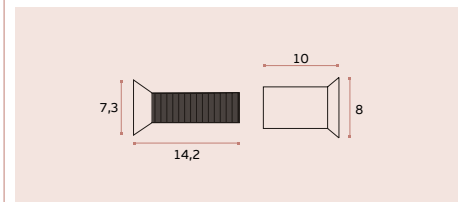

SM.015

União de tubo a 90° - para tubo Ø25mm/
Tube connector at 90° - for Ø25mm tube /
Union de tubo a 90° - para tubo Ø25mm.

EN 1.4301 Satinado / Satin / Satin

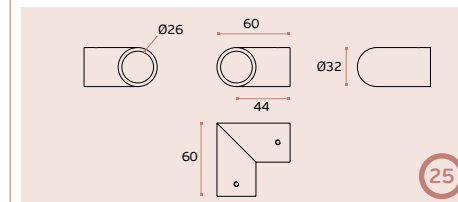

25



SM.02039

Fecho com indicador "livre-ocupado" /
Bathroom latch with indicator /
Cierre de baño con indicador.

Liga de Zinco Cor inox / Zinc alloy inox color /
Zamak color inox.

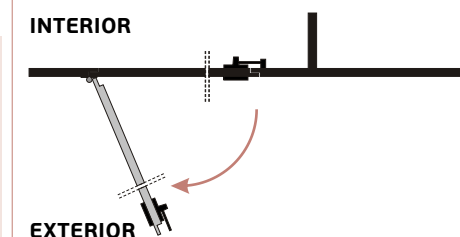
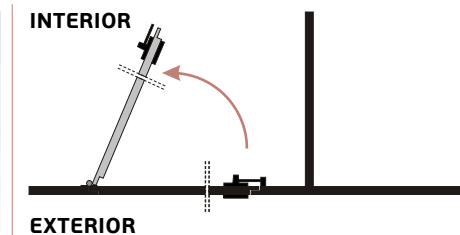
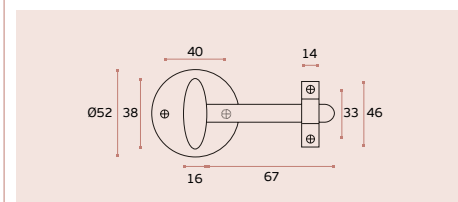

SISTEMAS MODULARES PARA CABINES SANITÁRIAS / SANITARY BOOTH HARDWARE / HERRAJES PARA CABINAS SANITÁRIAS.

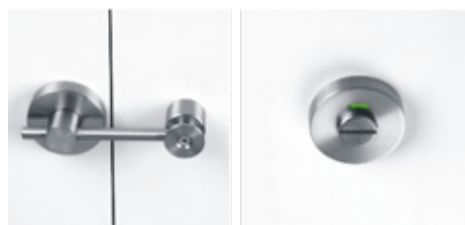

SM.026
Fecho com indicador "livre-ocupado" /
Bathroom latch with indicator /
Cierre de baño con indicador.
EN 1.4301 Satinado / Satin / Satin

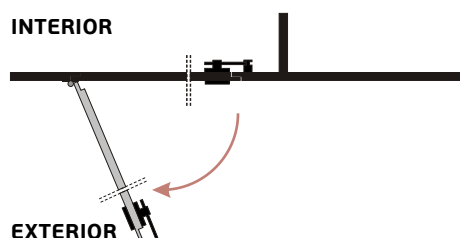
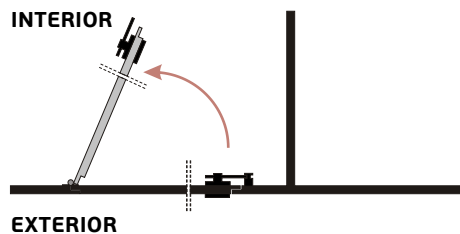
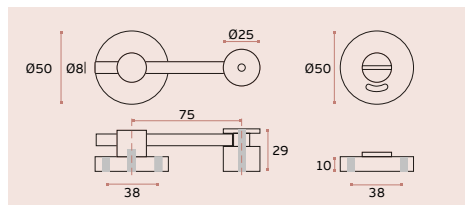

SM.029
Fecho com indicador "livre-ocupado" /
Bathroom latch with indicator /
Cierre de baño con indicador.
EN 1.4301 Satinado / Satin / Satin

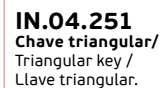

IN.04.251
Chave triangular /
Triangular key /
Llave triangular.

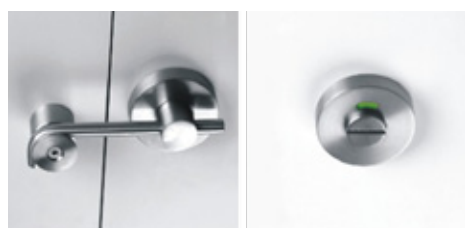
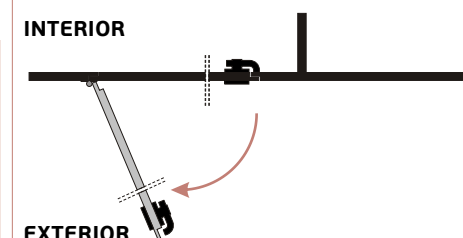
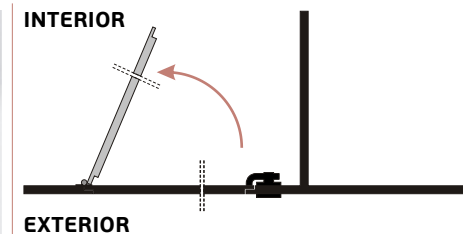
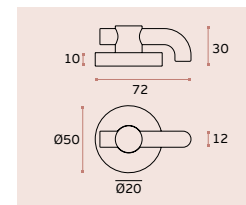

SM.027
Fecho para wc com indicador "livre-ocupado" para
portas de correr /
Bathroom latch for sliding door with indicator /
Cierre de baño para puertas correderas con indicador.
EN 1.4301 Satinado / Satin / Satin

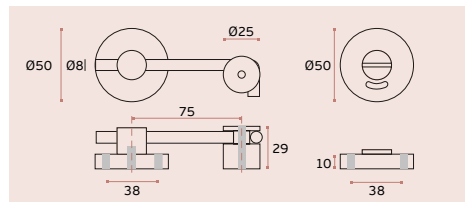

SM.030
Fecho para wc com indicador "livre-ocupado" /
Bathroom latch for sliding door with indicator /
Cierre de baño para puertas correderas con indicador.
EN 1.4301 Satinado / Satin / Satin

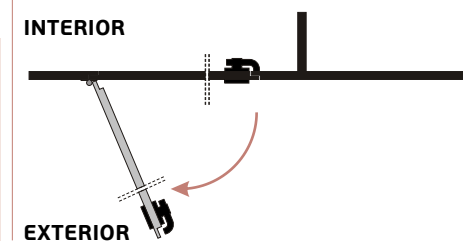
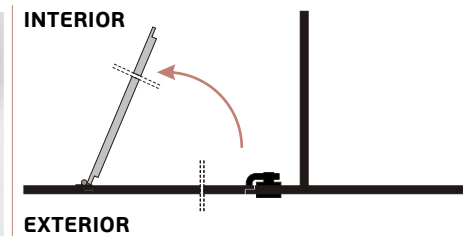
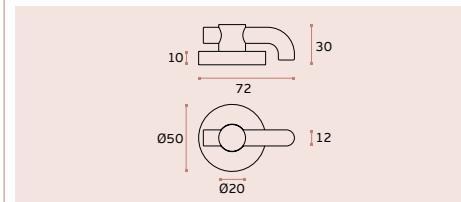

SISTEMAS MODULARES PARA CABINES SANITÁRIAS / SANITARY BOOTH HARDWARE / HERRAJES PARA CABINAS SANITÁRIAS.

EASY FIX

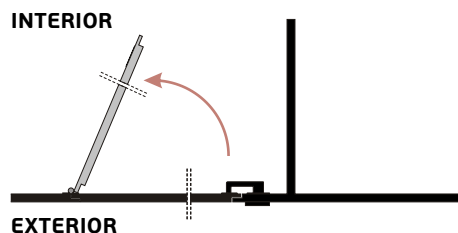

SM.031

Fecho com indicador "livre-ocupado" /
Bathroom latch with indicator /
Cierre de baño con indicador.
EN 1.4301 Satinado / Satin / Satin

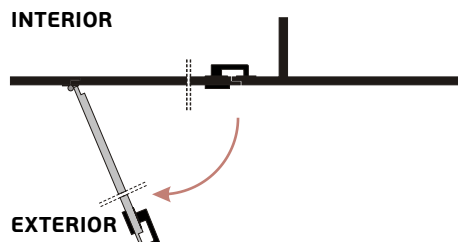
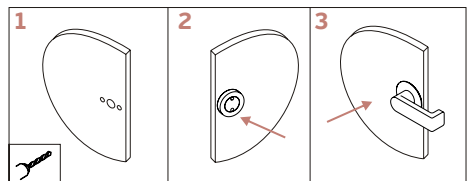

MODELO PATENTEADO / PATENTED MODEL / MODELO PATENTADO

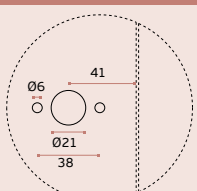
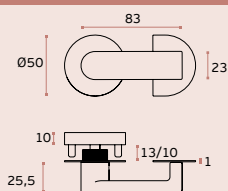

Furação para painel fenólico /
Drilling for phenolic panel /
Talladro para panel fenolico.

1- Botão de fecho com sistema de montagem rápida /
Locking button with quick assembling system /
Botón de bloqueo con sistema de montaje rápido.

2- Anilha anti fricção / Anti friction washer /
Arandella anti fricción.

3- Espelho em aço inox / Stainless steel cover /
Roseta en acero inox.

4- Indicador livre/ocupado, pode ser optado na instalação /
Indicator for snib indicator, can be chosen on instalation /
Indicador de cierre baño, opcional en la instalacion.

5- chave para desbloqueio /Unlocking key /
Llave de desbloqueo

6- Fecho exterior / Outside Lock / Cierre exterior.
7- Chapa testa em Aço inox EN 1.4301 /
Strike plate made in Stainless

steel EN 1.4301 / Cerradero en Acero Inox EN 1.4301
8- Chave para remoção do botão / Key to remove the
button / Llave para quitar el botón.

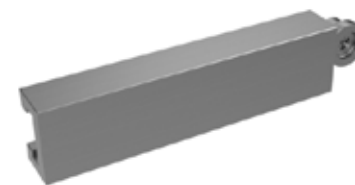
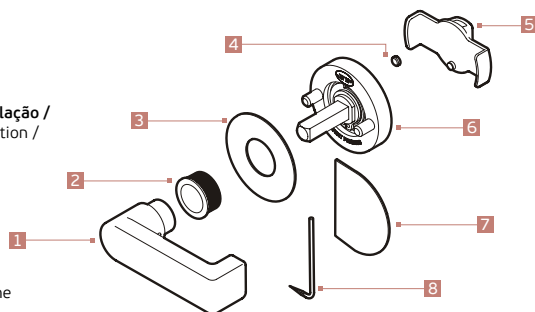

SM.035 - Satinado / Satin / Satin
SM.035.P - Polido / Mirror / Pulido
Fecho / Bolt / Pasador.
EN 1.4301

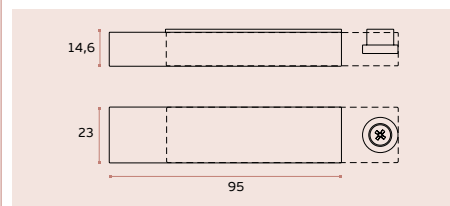

SM.050

Fecho para wc com indicador "livre-ocupado" /
Bathroom latch for sliding door with indicator /
Cierre de baño para puertas correderas con indicador.
EN 1.4372 Satinado / Satin / Satin

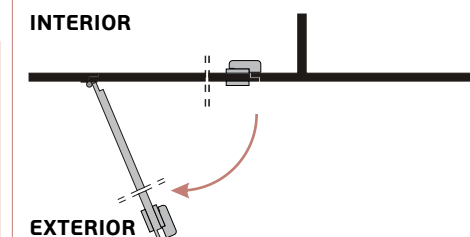
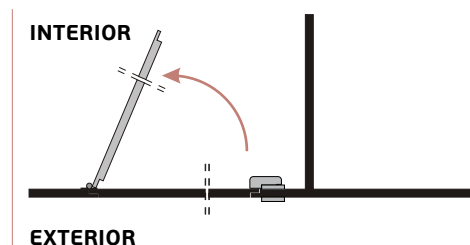
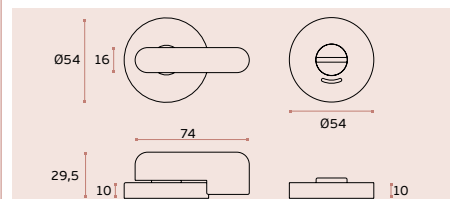

SISTEMAS MODULARES PARA CABINES SANITÁRIAS / SANITARY BOOTH HARDWARE / HERRAJES PARA CABINAS SANITÁRIAS.



SM.004
Suporte para painel /
Panel holder /
Soporte para panel.
EN 1.4301 Satinado / Satin / Satin



SM.044
Suporte para painel /
Panel holder /
Soporte para panel.
EN 1.4301 Satinado / Satin / Satin



SM.034
Suporte para painel /
Panel holder /
Soporte para panel.
EN 1.4301 Satinado / Satin / Satin



SM.039
Suporte para painel /
Panel holder /
Soporte para panel.
EN 1.4301 Satinado / Satin / Satin

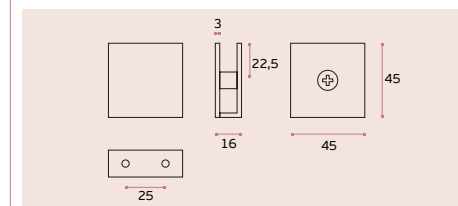
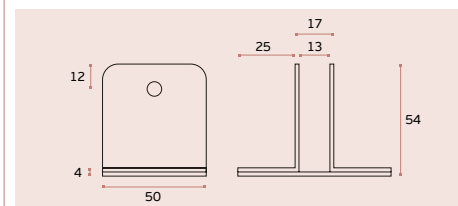
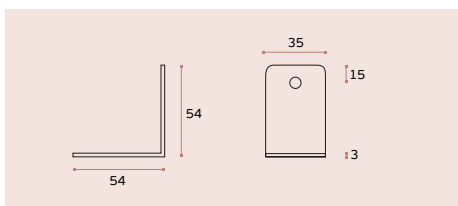
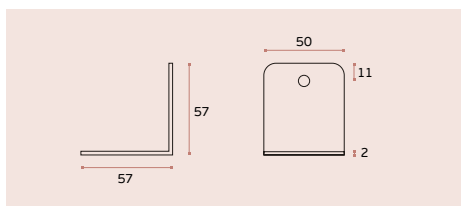

SM.014
Suporte para painel /
Panel holder /
Soporte para panel.
EN 1.4301 Satinado / Satin / Satin



SM.024
Suporte para painel /
Panel holder /
Soporte para panel.
EN 1.4301 Satinado / Satin / Satin

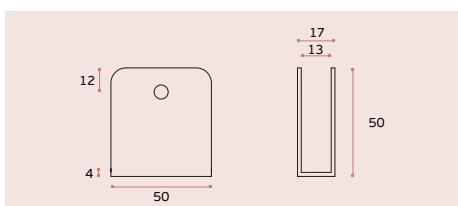
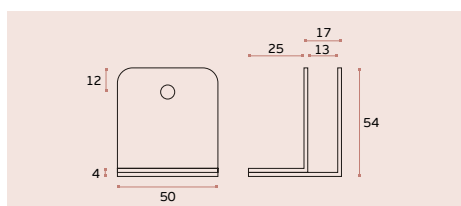

SM.101
Perfil em "U" para painel de 13mm /
"U" shape profile for 13mm panel /
Perfil en "U" para panel de 13mm.
EN 1.4301 Satinado / Satin / Satin

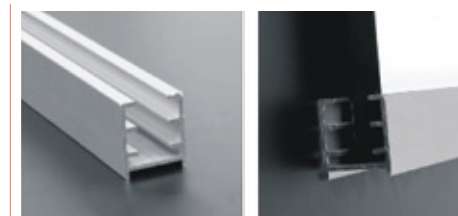

SM.103
Perfil para painel de 13mm /
Profile for 13mm panel /
Perfil para panel de 13mm.
Alumínio / Aluminium / Aluminio
Cor natural / Natural color / Color natural

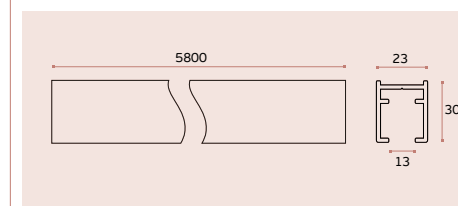
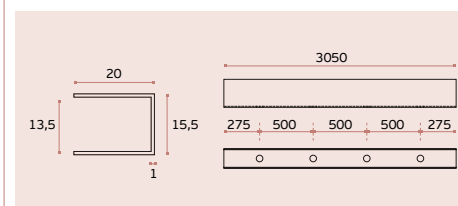

SISTEMAS MODULARES PARA CABINES SANITÁRIAS / SANITARY BOOTH HARDWARE / HERRAJES PARA CABINAS SANITÁRIAS.



SM.008
Cabide / batente de porta anti-vandalismo /
Hook / door stopper concealed fixing /
Percha / tope de puerta anti-vandalismo.
EN 1.4301 Satinado / Satin / Satin

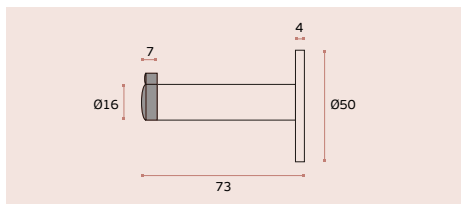

IN.14.529
Cabide duplo com batente de porta /
Double hook with door stopper /
Colgador doble con tope de puerta.
EN 1.4301 Satinado / Satin / Satin

Também disponível na versão: /
Also available in version: /
También disponible en la versión: /
EN 1.4372

ECO
series

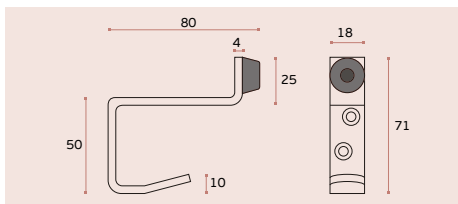

SM.019
Puxador de porta duplo, anti-vandalismo /
Back to back door knob, anti vandalism fixing /
Tirador de puerta doble, anti vandalismo.
EN 1.4301 Satinado / Satin / Satin

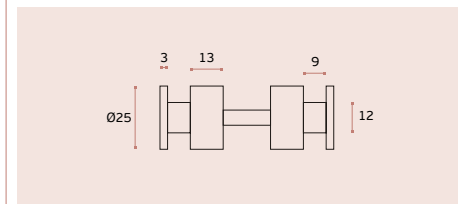

SM.020
Puxador de porta duplo, anti-vandalismo /
Back to back door knob, anti vandalism fixing /
Tirador de puerta doble, anti vandalismo.
EN 1.4372 Satinado / Satin / Satin

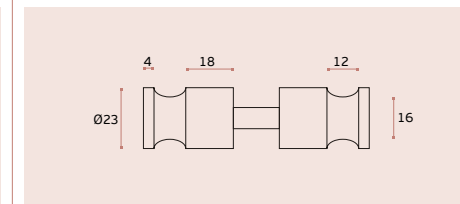

IN.14.530.ECO
Cabide duplo /
Double hook /
Colgador doble.
EN 1.4372 Satinado / Satin / Satin

ECO
series

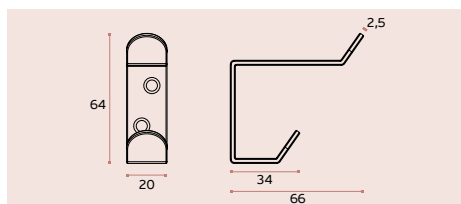

IN.75.030
Puxadores para portas de vidro ou fenólico /
Knobs for glass or phenolic doors /
Pomos para puerta de cristal o fenolico.
Material EN 1.4301 Satinado / Satin / Satin

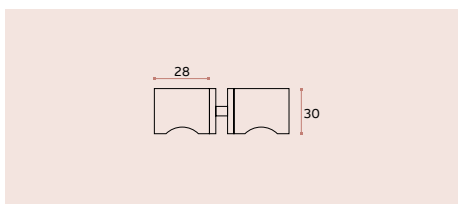

SISTEMAS MODULARES PARA CABINES SANITÁRIAS / SANITARY BOOTH HARDWARE / HERRAJES PARA CABINAS SANITÁRIAS.

Sistema para cabines sanitárias especialmente desenvolvido para pessoas com mobilidade reduzida.
Sistema de porta de correr para painéis fenólicos de 13mm.
O sistema de fecho está preparado para utilizadores com mobilidade reduzida, e um sistema de segurança permite desbloquear o fecho pelo exterior em caso de qualquer emergência.

System for Sanitary cabinets specially designed for people with reduced mobility.
Sliding door system for phenolic panels with 13mm.
The lock system is ready for users with reduced mobility, and it's provided with a security system to unlock the system from the outside in case of any emergency.

Sistema para cabinas sanitarias especialmente diseñado para personas con movilidad reducida.
Sistema de puertas correderas de paneles fenólicos con 13mm.
El sistema de cierre está valido para los usuarios con movilidad reducida, tiene un sistema de seguridad para desbloquear el sistema por el exterior en caso de cualquier emergencia.

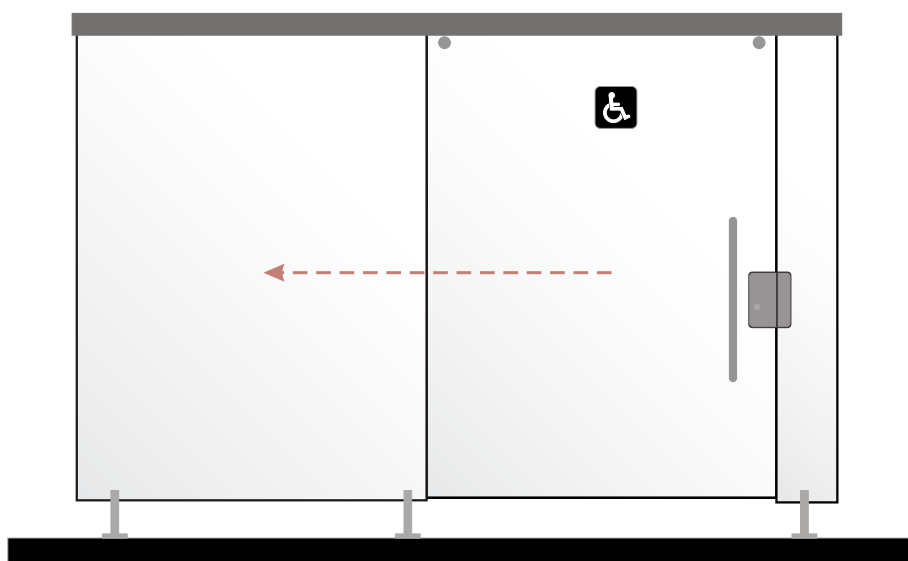

SM.036

Fechadura para portas de correr, para aplicar com fecho livre-ocupado. Testa para parede incluída/
Lock for sliding door to use with snib indicator.
Strike plate included /
Cerradura para puertas correderas para aplicar con condena de baño. Cerradero incluido.
EN 1.4301 Satinado / Satin / Satin

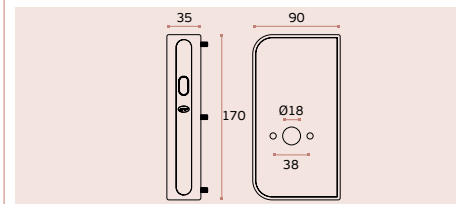

SM.037

Fechadura para portas de correr, para aplicar com cilindro. Testa para parede incluída/
Lock for sliding door to use with european cylinder.
Strike plate included /
Cerradura para puertas correderas para aplicar con bombillo. Cerradero incluido.
EN 1.4301 Satinado / Satin / Satin

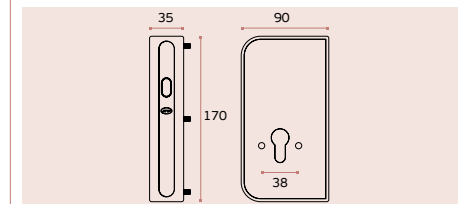

SM.038

Testa para aplicar com SM.036 e SM.037 (não incluída) /
Strike plate to use with SM.036 and SM.037 (not included)/
Cerradero para aplicar con SM.036 y SM.03 (no incluido).
EN 1.4301 Satinado / Satin / Satin

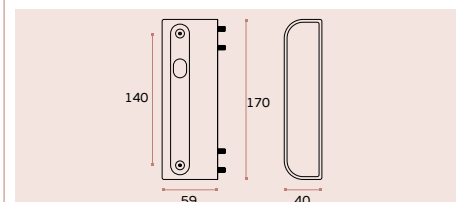

IN.04.110

Fecho WC com ranhura para moeda /
Bathroom snib indicator with coin slot /
Condena de baño con fenda para moneda.
EN 1.4301 Satinado / Satin / Satin

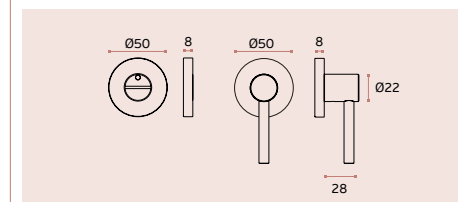

SISTEMAS MODULARES PARA CABINES SANITÁRIAS / SANITARY BOOTH HARDWARE / HERRAJES PARA CABINAS SANITÁRIAS.

IN.15.258

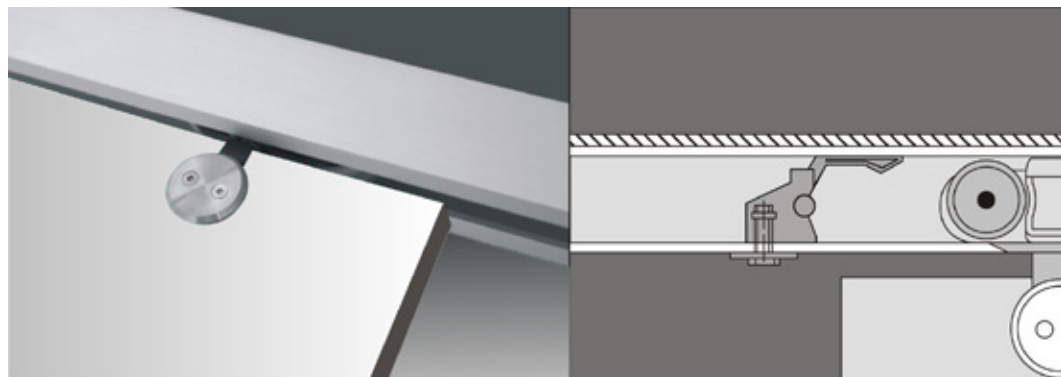

2x- Roldanas com suporte para fenólico /
2x- Wheels with phenolic support /
2x- Ruedas con soporte para fenolico.

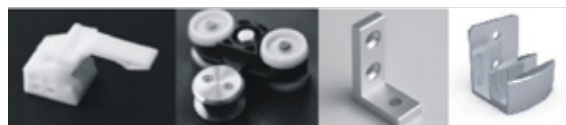

2x- Travões /
2x- Stoppers /
2x- Frenos.



2x- Suportes de parede /
2x- Wall supports /
2x- Soportes de pared.



1x- Guia inferior para fenólico /
1x- Lower guide to phenolic /
1x- Guia de bajo para fenólico.



2900mm- Calha de alumínio (pode ser cortada) /
2900mm- Aluminium track (can be cutted) /
2900mm- Guia en aluminio (puede ser cortada).

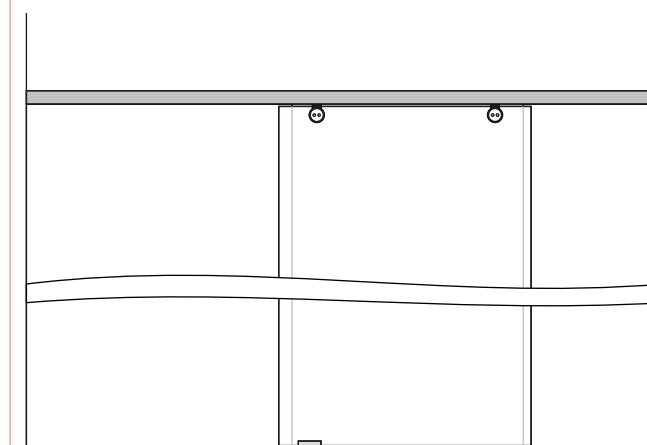
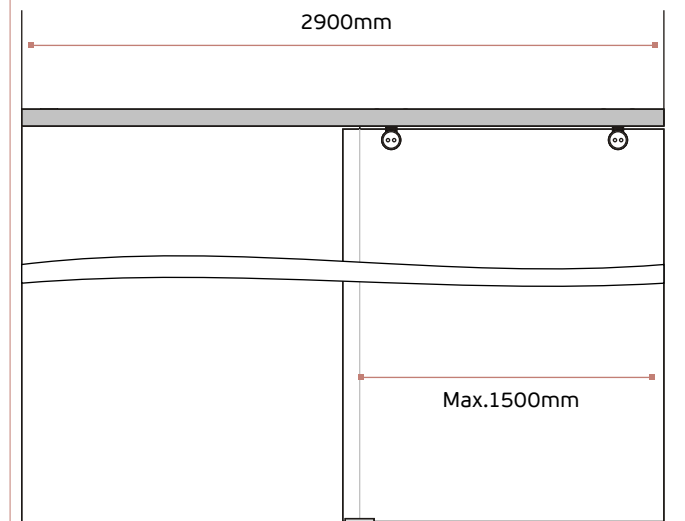

Medidas dos furos a efectuar na porta do fenólico /
Sizes of the holes to be made in the phenolic door /
Medidas de los taladros en la puerta en fenolico.

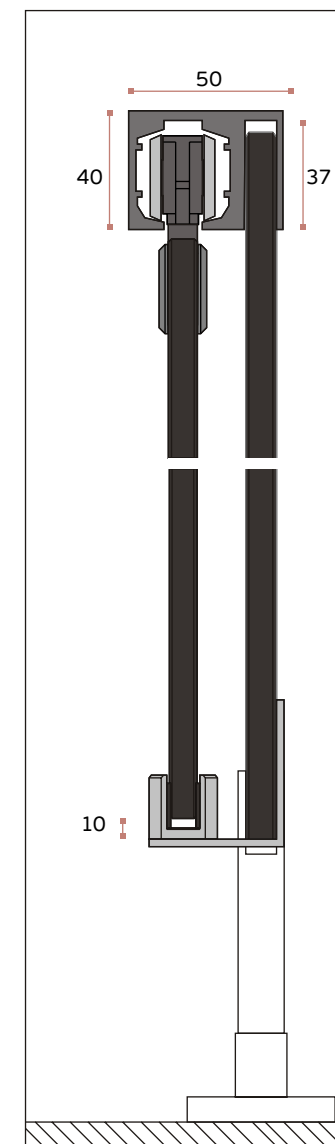
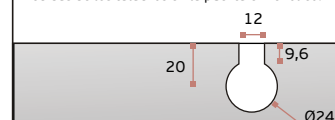

Largura máx. da porta / Max. door length / Anchura max. de la puerta - 1500mm
Peso máx. da porta / Max. door weight / Peso max. de la puerta - 60Kg
Espessuras de fenólico / Phenolic thickness / Espesor de lo fenolico - 8-10-12mm.